



TOS - CUBES

SELF-BUNDED TRANSPORTABLE CUBE RANGE

GLOBAL ENGINEERING SOLUTIONS FUEL CUBE THAT IS SELF
BUNDED AND TRANSPORTABLE WITH LOCKABLE CABINETS
AND MULTIPLE OPTIONS FOR DRAWING FUEL

PUMPING OPTIONS

80 litres per minute solar pumping-off grid, 8mt auto nozzle

80 litres per minute mains power with a mechanical meter

80 litres per minute Fuel Management System



STANDARD FEATURES

- 📄 Self-bunded and transportable with lockable cabinet on the front
- 📄 Setup for Diesel or Gasoline
- 📄 3 inches fill point with camloc and cap

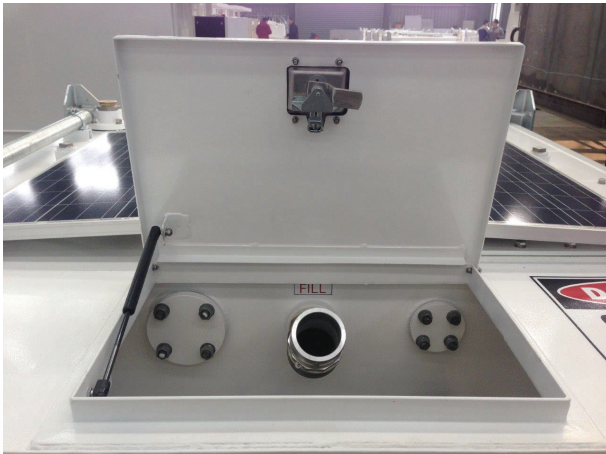

- 📄 Multiple options for drawing fuel from the tank
- 📄 Genset lines and provisions
- 📄 Forklift and crane lifting points

- 📄 Hot dipped corner posts for protection
- 📄 Stackable for transporting
- 📄 Statutory decals fitted

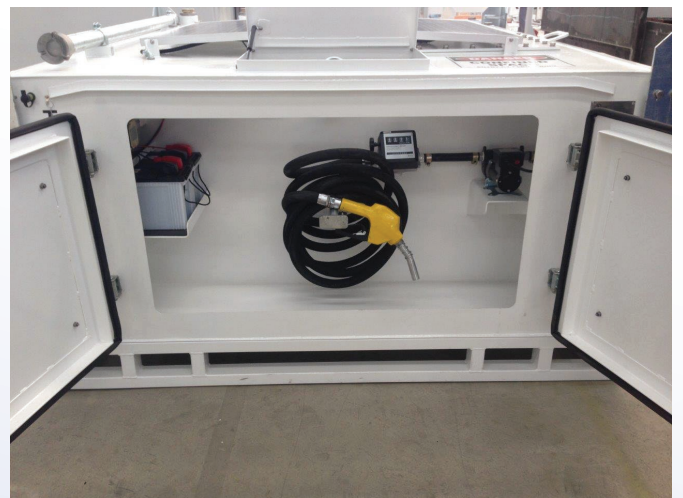



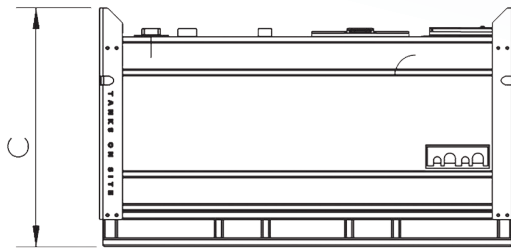
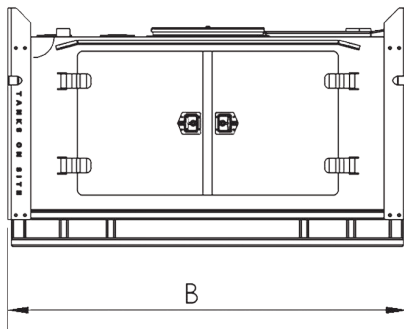
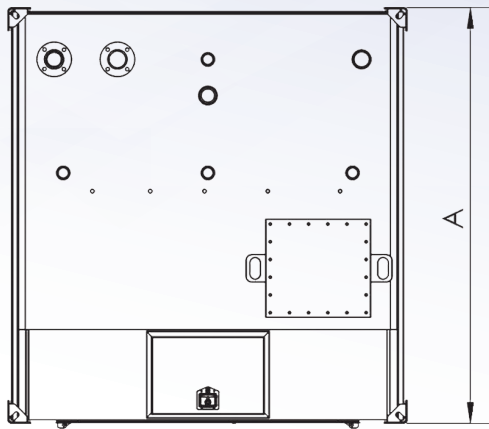

TOS-CUBES-GA DRAWING



MODEL NUMBER	SAFE FILL LEVEL LITRES)	LENGTH A	WIDTH B	HEIGHT C	WEIGHT (EMPTY)	UNITS PER 40FT CONTAINER
TOS-1	1000	1645	1130	1320	700 KG	32
TOS-2	2000	2200	1426	1320	1050KG	16
TOS-3	3000	2300	2209	1320	1400KG	16
TOS-4	4000	2745	2209	1320	1650KG	8
TOS-5	5000	3300	2209	1320	1850KG	8

CERTIFICATIONS

-  **AS 1692-2006** Steel tanks for flammable and combustible liquids
-  **AS 1940-2004** Storage and handling of flammable and combustible liquids
-  **CAN/ULC-S601** Shop fabricated steel aboveground tanks for flammable and combustible liquids
-  **SANS 10131 Ed.1 (2004)** Above-ground storage tanks for petroleum products
-  **UL 142** Aboveground flammable liquid tanks

FOR MORE INFORMATION, PLEASE CONTACT

Ground Forces Solutions

Email: info@groundforcesolutions.com.au

Phone: 1300 969 666